

## DD05 Series DC RGBW Controller

Made in China.

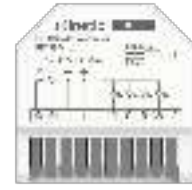

DD05 & DD05-MW& DD05-WF

### DESCRIPTION

- 4-channels RGBW, 5A max per channel, 5A total shared max.
- A compact RF&Smart RGBW controller offers high flexibility for LED lighting color controls.
- Screw-free terminal as standard to provide fast installation.
- Dimming and White/RGB tuning can also be controlled via a standard push-button switch.
- 12-48Vdc input is ideal for RGBW LED strip, furniture lighting and other low voltage DC LED application.

### FEATURES

1. Encrypted RF transmission, anti-interference ability.
2. 0.1-100% logarithmic dimming curve.
3. Minimum dimming level is adjustable.
4. Power cut memo function available.
5. Built-in overcurrent protection.
6. Smart and RF control works interactively.

### SPECIFICATION

#### ONLY RF VERSION (R433MHZ)

Model	DD05
Type	DC PWM RGBW Controller
Channel	1CH
Input Voltage	12V-48V
Output Voltage	12V-48V
Output Current	Max 5A
Load Power	12V<60W;24V<120W ;36V<180W;48V<240W
Radio frequency	RF433Mhz
DMT	ASK
PWM	4KHz
Dimming Curve	0.1-100% Logarithmic
Memory Capacity	Maximum 10 switches
Wall switch Compatible	Support push button switch
Housing Material	UL 94-V0
IP Rating	IP20
Operating Temperature	-20°C -+40°C
Ta/Tc	Ta: 40°C Tc: 85°C
Dimensions	42mm*42mm*16.5mm
Warranty	5 years

## SMART VERSION (RF433Mhz+Matter Over WiFi)

Model	DD05-MW
Protocal	2.4Ghz for Matter Over Wi-Fi
Wi-Fi Security Protocol	WEP, WPA/WPA2, WPA/WPA2 PSK (AES), WPA3
Wireless Frequency	2.400-2.480GHz
APP	Homekit, Smarthings, Google home, Tuya Smartlife, Alexa, Yandex

**\*Note:**

- Smart receivers supports RF function which is based on RF433Mhz.
- Matter is an open protocol based on local communication, and workable under disconnected network.
- To enable Matter device operation, a compatible third-party smart speaker corresponding to your chosen app is required. Remote control is supported, excluding Tuya Smartlife.
- Matter devices using the Tuya Smartlife app support local control only and certain functions on Smartlife app may not be fully available or display due to Tuya-Matter compatibility issues.

## SMART VERSION (RF433Mhz+Tuya Over WiFi)

Model	DD05-WF
Protocal	2.4Ghz for Tuya Over Wi-Fi
Wi-Fi Security Protocol	WEP, WPA/WPA2, WPA/WPA2 PSK (AES), WPA3
Wireless Frequency	2.400-2.480GHz
APP	Tuya Smartlife, Google Home, Amazon Alexa

**\*Note:**

Smart receivers supports RF function which is based on RF433Mhz.  
 To work with Smart Speaker or Home automation system, please check Tuya official website for further information.

## WIRING DIAGRAM

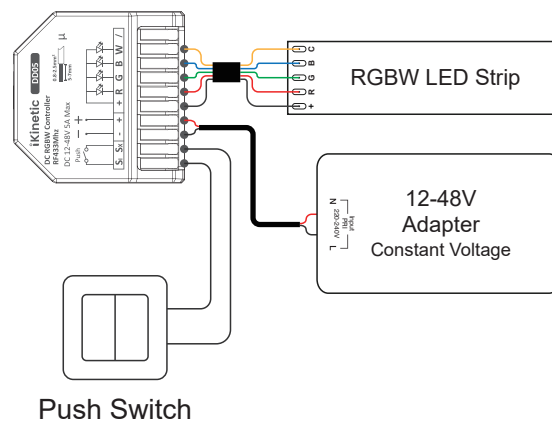
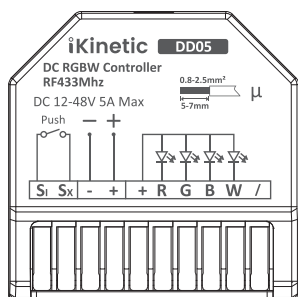

\*Note: One receiver can be configured with up to 10 wireless switches.

## DC RGBCW CONTROLLER APPLICATION

### Controller Installation Method

Can be mounted in electrical boxes or on ceiling surface.

### Application Scenarios

Widely used in smart home ,residential,office ,classrooms, hotel,commercial space,ect.

Suitable for smart lighting control DIY retrofits, wireless switch can be placed at will.

### Product Composition

\*Transmitter need to be purchased separately

#### Kinetic Switch



**On/ Off:** Press right key once  
**Dimming:** Press the right key twice to enter dimming cycle, another press to lock in your selection  
**CCT&RGB:** Press the left key once to enter CCT or RGB color cycling mode, press again to lock in your selection  
**Toggle CCT&RGB mode:** Double press left key  
**Optional:** 2G/3G+color

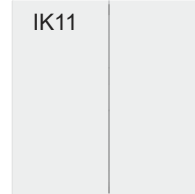

**On/ Off:** Press right key once  
**Dimming:** Long press right key  
**CCT&RGB:** Press the left key once to enter CCT or RGB color cycling mode, press again to lock in your selection  
**Toggle CCT&RGB mode:** Double press left key  
**Optional:** 2G/3G+color

#### Battery Switch



Each button works independently  
**On/Off:** Press once  
**Dimming:** Long press  
**CCT&RGB:** Single click+long press to enter CCT or RGB color cycling mode. Release to lock in your selection  
**Toggle CCT&RGB mode:** Double press  
**Optional:** 1G/2G/3G+Surface (Plastic/ Polished/ Brushed)+ Color

#### Battery remote (TR series)



**On/ Off:** single press ①/②  
**Dim ▲/Dim ▼:** long press ①/②  
**CCT&RGB:** single click+long press ② to enter CCT or RGB color cycling mode. Release to lock in your selection  
**Toggle CCT&RGB mode:** double press ②  
**Optional:** Surface (Plastic/ Glass) + Color

2 Key 1 Group Remote (TR01/TR11)



**On/ Off:** single press ①  
**Dim ▲/Dim ▼:** long press or single press ②  
**CCT&RGB:** single press or long press ③  
**Toggle CCT&RGB mode:** long press ④  
**Switch Group:** single press ④  
**Optional:** Surface (Plastic/ Glass) + Color

4 Key 4 Group Remote (TR03/TR13)

#### Battery remote (BR series)



**On/ Off:** single press ①/②  
**Dim ▲/Dim ▼:** long press ①/②  
**CCT&RGB:** single click+long press ② to enter CCT or RGB color cycling mode. Release to lock in your selection  
**Toggle CCT&RGB mode:** double press ②  
**Optional:** Surface (Plastic/ Glass) + Color



Alexa



HomeKit



Google Home



SmartThings



SmartThings



tuya

\*Note: Refer to the USER MANUAL for application and pairing methods.

TEST DATA

Max.Output Current TR Data

DD05	INPUT VOLTAGE=24(V) ;INPUT CURRENT=5(A); Ta: 33.5°C ; TEST TIME: 2H						
Data Channel	CH01	CH02	CH03	CH04	CH05	CH06	CH07
Key componment	Mos 1	Mos 2	Mos 3	Mos 4	Mos 5	Capacitor	Case
Temperature(°C)	58.8	58.2	58.3	58.0	63.8	55.3	48.5
Temperature Limit(°C)	150	150	150	150	150	105	105

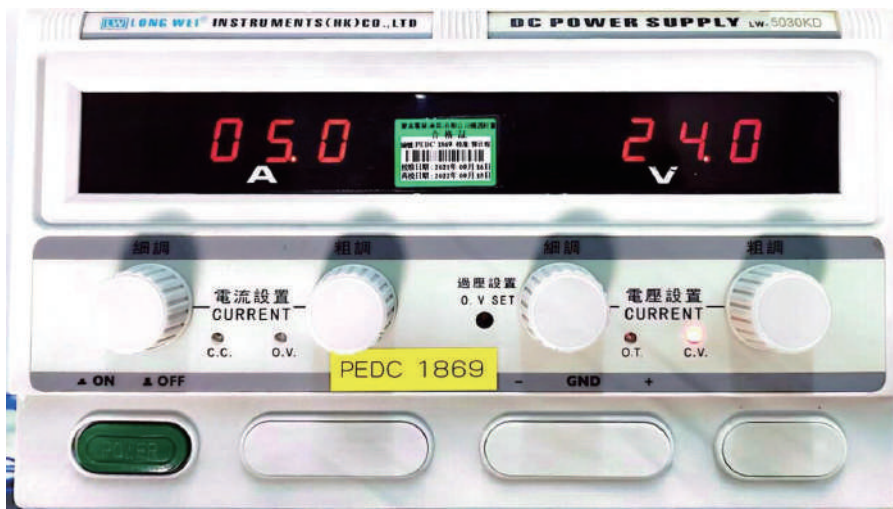

Fig. 1:Power Supply



Fig. 2:Multi-channel Temperature recorder

DD05	INPUT VOLTAGE=48(V) ;INPUT CURRENT=5(A); Ta: 34.4°C ; TEST TIME: 2H						
Data Channel	CH01	CH02	CH03	CH04	CH05	CH06	CH07
Key componment	Mos 1	Mos 2	Mos 3	Mos 4	Mos 5	Capacitor	Case
Temperature(°C)	65.7	59.9	57.7	54.2	54.4	62.9	52.1
Temperature Limit(°C)	150	150	150	150	150	105	105

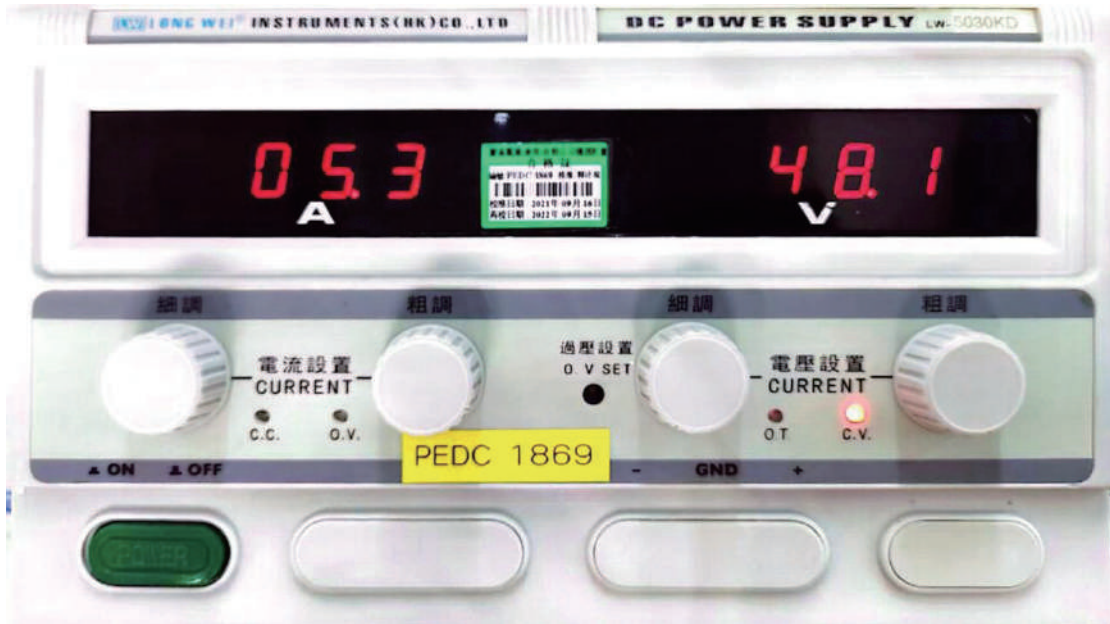
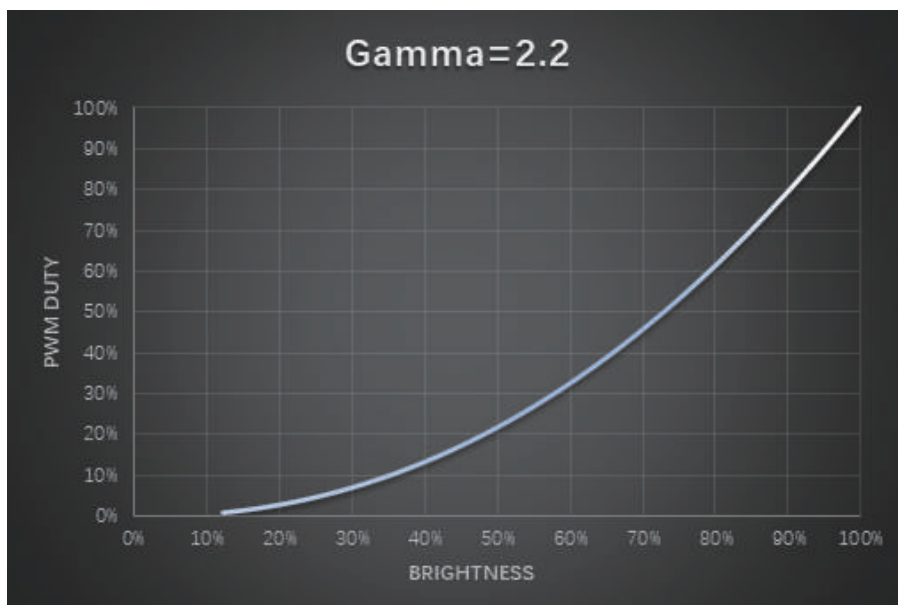

Fig. 1: Power Meter



Fig. 2: Multi-channel Temperature recorder

## Dimming curve setting



Logarithmic dimming curve

## IKINETIC SMART LIGHTING SOLUTION

- **Smart Home Lighting Upgrade:** Supports Matter over Wi-Fi, allowing seamless integration into smart home ecosystems with app control, voice activation, and scheduled dimming.
- **Energy-Efficient Commercial & Office Lighting:** Enables 0-100% precise dimming, optimizing energy use based on ambient lighting conditions, reducing power consumption.
- **Indoor Lighting Retrofit Solutions:** Compatible with Ikinetic wireless switches (433MHz), making it ideal for both new installations and retrofitting existing lighting systems without additional wiring.
- **Compact Installation for Various Fixtures:** The small form factor allows easy integration into recessed lighting, linear lights, track lights, and panel lights.

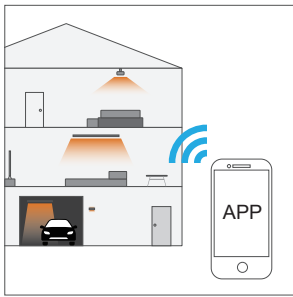

Smart Home Lighting Upgrade

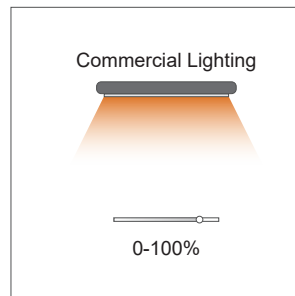

Energy-Efficient Commercial  
& Office Lighting

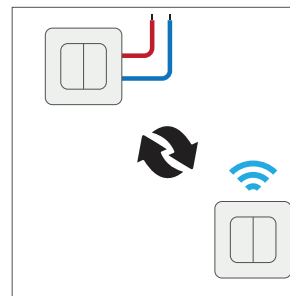

Indoor Lighting Retrofit  
Solutions

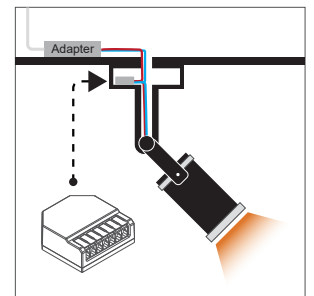

Compact Installation  
for Various Fixtures

## NOTE

- Please supply with correct DC power supply between 12-48Vdc.
- Kindly note the maximum load power of the controller.
- You might need smart speaker to allow Matter over WiFi device working. Please check with smart speaker manufacturer if the model is matter supported.
- Transmission distance refer to transmitter user manual.
- The DC dimmer and RF switch shall be installed 20cm away from any metal surface and strong electromagnetic wave nearby to give better performance.
- Damage caused by incorrect installation and operation are not covered under warranty.

## CAUTIONS

- Ensure that the power is turned off before carrying out electrical installation.
- Do not short-circuit and over-load, it may cause permanent damage to the receiver.
- If a fault occurs, please seek advice from a local supplier.