

HF Aisle Sensor

HCD450VDSRC

Tri-level Control with Daylight Harvest and Remote Control

HYTRONIK®

Applications







Occupancy detector with tri-level dimming control suitable for below applications:

- Warehouse
- Large storage room

Use for retrofit and new luminaire designs/installations



Features

-  Daylight harvest function to regulate light output for maintaining required lux level
-  Tri-level dimming control based upon occupancy (also known as corridor function)
-   Optional 1-10V or DALI dimming control method
-  One-touch daylight learning via remote control
-  Loop-in and loop-out terminal for efficient installation
-  5-Year Warranty

Technical Data

Input Characteristics

Model No.	HCD450VDSRC
Mains voltage	120~277VAC 50/60Hz
Stand-by power	<0.5W
Load ratings:	
Capacitive	2 x 400VA @ 120VAC 2 x 1000VA @ 220-277VAC
DALI switched power	Max. 20 devices
Warming-up	20s

Safety and EMC

EMC standard (EMC)	EN55015, EN61000
Safety standard (LVD)	EN60669
Radio Equipment (RED)	EN300440, EN301489, EN62479
Certification	Semko, CB, CE, EMC, RED, RCM

Sensor Data

Model No.	HCD450VDSRC
Sensor principle	High Frequency (microwave)
Operation frequency	10.525GHz +/- 75MHz
Transmission power	<0.2mW
Mounting height:	Max. 15m
Detection angle	30° ~ 150°

Environment

Operation temperature	Ta: -20°C ~ +50°C
Case temperature (Max.)	Tc: +80°C
IP rating	IP54

CE emc RED   CB IP54

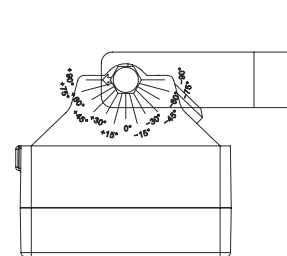
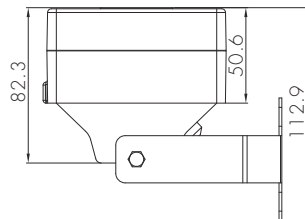
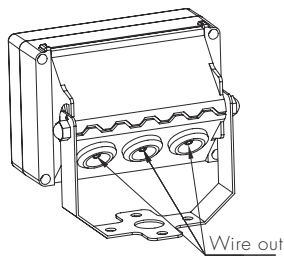
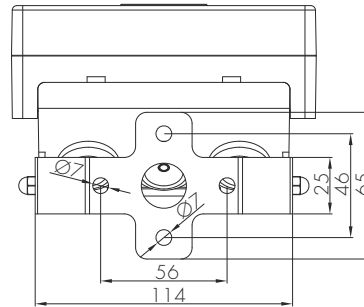
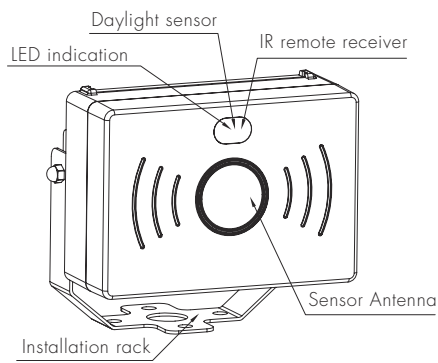
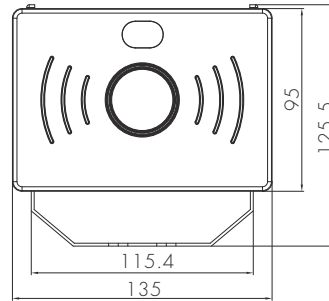
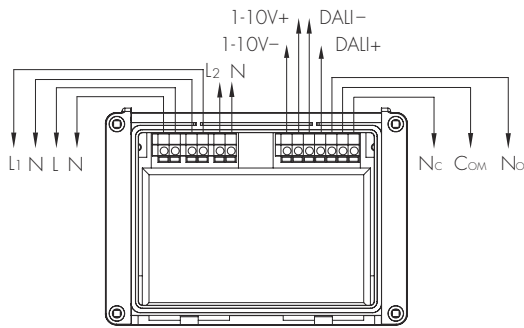

Note: We recommend the mounting distance between sensor to sensor should be more than 2m to prevent sensors from false-triggering.

Functions and Features

1 Tri-level Control (Corridor Function)

Hytronik builds this function inside the motion sensor to achieve tri-level control, for some areas which require a light change notice before switch-off. The sensor offers 3 levels of light: 100% -> dimmed light (natural light is insufficient) -> off; and 2 periods of selectable waiting time: motion hold-time and stand-by period; Selectable daylight threshold and freedom of detection area.

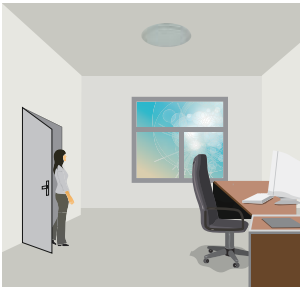

With sufficient natural light, the light does not switch on when presence is detected.

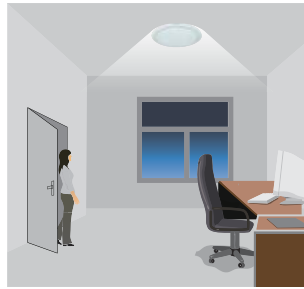

With insufficient natural light, the sensor switches on the light automatically when presence is detected.

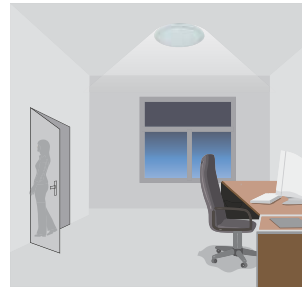

After hold-time, the light dims to light stand-by level.



Light switches off automatically after the stand-by period elapses.

Note: this function requires the max. dimming level setting, press  on the RC to the max. Otherwise it behaves like daylight harvesting. (daylight regulating)

2 Daylight Harvest Function



Light will not switch on when natural light is sufficient, even there is motion detected.

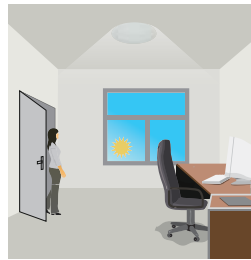

The light switches on automatically with presence when natural light is insufficient.

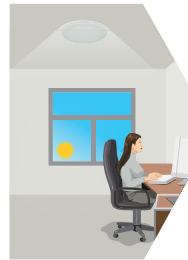

The light turns on at full or dims to maintain the lux level. The light output regulates according to the level of natural light available.

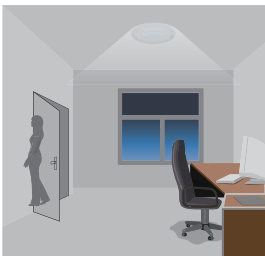
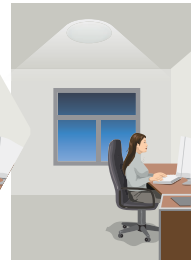
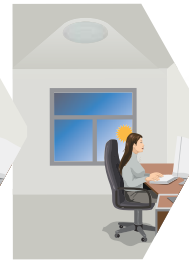
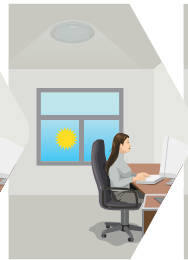

The light dims to stand-by period after hold-time and stays on selected minimum dimming level.

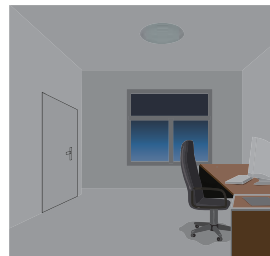

The light switches off completely after the stand-by period.

Note:
If the stand-by period is set at "+∞", the fixture never switches off but dim to minimum level, even when natural light is sufficient.

3 DALI Control

This sensor contains an independent DALI power supply circuit, which broadcast command to the devices to achieve on/off and dimming function. Maximum 35 devices can be connected.

4 Dry Contact Control

Sometimes also known as "Potential-Free" or "Volt-Free" sensor, the dry contact sensors from Hytronik are designed to operate with external monitoring systems. They operate as conventional occupancy sensors, with the output available as shown in the table on the right:

Detection State	Contacts Mode
Presence	No - Com
Absence	Nc - Com

5 Loop-in and Loop-out Terminal

Double L N terminal makes it easy for wire loop-in and loop-out, and saves the cost of terminal block and assembly time.

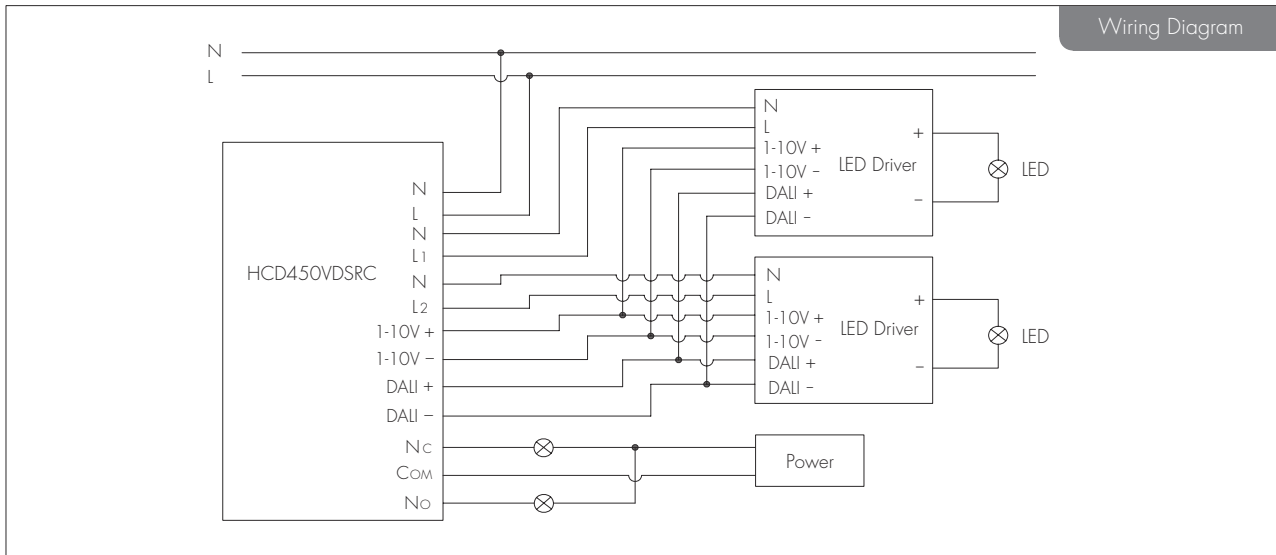

Settings (Remote Control HRC-05)



Permanent ON/OFF function

Press the "ON/OFF" button, the light goes to permanent on or permanent off mode, and the sensor is disabled.

* Press "Auto Mode", "RESET" or "Scene mode" buttons to quit this mode. The mode will change to AUTO Mode after power failure.



Sensor mode

Press "Auto Mode" button, the sensor starts to function and all settings remain the same as the latest status before the light is switched on/off.



Reset function

Press "RESET" button, all settings go back to default settings.



Dim +/-

Long press "Dim +" or "Dim -" to adjust the target lux level during hold-time. "+" means increasing the target, "-" means decreasing the target.



Test mode

This button is for testing purpose only. The sensor goes to test mode (hold-time is 2s) after commissioning, meanwhile the stand-by period and daylight sensor are disabled.

* This mode can be ended by pressing "reset", or any button of "scene mode" and "hold-time". The sensor settings are changed accordingly.



Power output

By pressing these two buttons, the output shifts between 80% (at initial 10,000 hours) and 100%, for energy saving purpose.

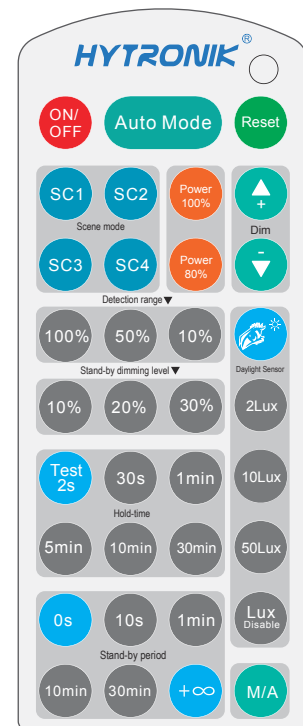

HRC-05

Note: the light will flash ONCE rapidly after receiving the command from the remote control successfully.



Ambient daylight threshold

Press this button, the latest surrounding lux value overwrites the previous lux value learned, and it is set as the daylight threshold. This feature enables the fixture to function well in any real application circumstances.



Lux disable

Press this button, the built-in daylight sensor stops working, and all motion detected could turn on the lighting fixture, no matter how bright the natural light is.

Scene mode

There are 4 scene modes fixed program built in the remote control to choose for different applications:

Scene options	Detection range	Hold-time	Stand-by period	Stand-by dimming level	Daylight sensor
SC1	100%	1min	10min	10%	2Lux
SC2	100%	5min	10min	10%	2Lux
SC3	100%	10min	30min	10%	10Lux
SC4	100%	10min	+∞	10%	50Lux

* End-user can adjust the settings by pressing buttons of detection range/hold-time/stand-by period/stand-by dimming level/daylight sensor. The last setting stays in validity.

Detection range

Press the buttons of "detection range" to set detection range at 10% / 50% / 100%.

Hold-time

Press the buttons of "hold-time" to set hold-time at 30s / 1min / 5min / 10min / 30min.

Daylight sensor

Press the buttons of "daylight sensor" to set daylight threshold at 2Lux / 10Lux / 50Lux. The fixture will not turn on if ambient natural light lux level exceeds the threshold preset when motion detected.

Stand-by period (corridor function)

Press the buttons of "stand-by period" to set stand-by period at 0s / 10s / 1min / 10min / 30min / +∞.

* "0s" means on/off control; "+∞" means bi-level dimming control, and the fixture never switches off.

Stand-by dimming level

Press the buttons of "stand-by dimming level" to set the stand-by dimming level at 10% / 20% / 30%.



Manual Override / Semi-auto mode (absence detection)

Button "M/A" is disabled.

Detection Pattern

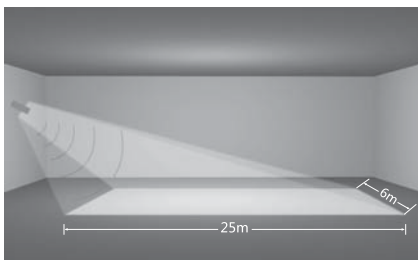

25m x 6m coverage @ 8m height

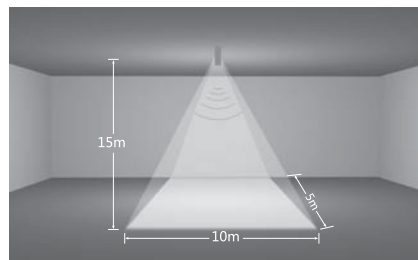

10m x 5m coverage @ 15m height (walk & stop)
6m x 4m coverage @ 15m height (continuous walking)

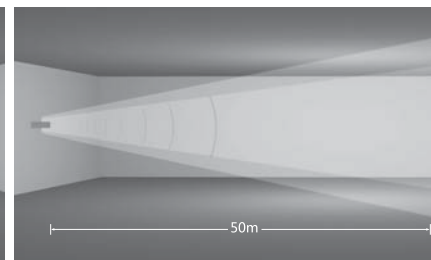

50m detection length @ 5m height

Additional Information / Documents

1. Regarding precautions for microwave sensor installation and operation, please kindly refer to
www.hytronik.com/download ->knowledge ->Microwave Sensors - Precautions for Product Installation and Operation
2. Regarding Hytronik standard guarantee policy, please refer to
www.hytronik.com/download ->knowledge ->Hytronik Standard Guarantee Policy