

Product features

CASAMBI

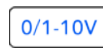

- Bridge between DALI / 0-10 V systems and wireless solutions
- Long-range, one-channel 0-10 V / DALI 2 controller
- Bluetooth-controlled Casambi-enabled
- Relay with zero-crossing, carries a maximum current of 10 A
- 5 year warranty

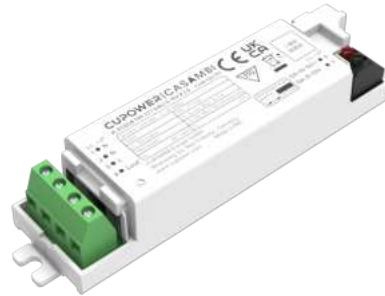

Electrical specifications

Mains voltage supply

Rated input voltage range	100...277 Vac
Max. Input current	0.06 A @ 100 Vac
RF transmit power	+ 8 dBm
Wireless frequency	2.4 GHz
Wireless range (open air)	50 m

Control output

Output 0-10 V	0...10 Vdc
Max 0-10V sinking current	50 mA
Output voltage DALI	14...16 Vdc
Output current DALI	100 mA
Relay control	10 A Max

Environmental specifications

Operating temperature	-20...+50°C
Storage temperature	-25...+85°C
Working humidity	0%...80%
Store humidity	0%...95%
Lifetime	at Tc 75°C: 50,000 hrs @ 100 Vac
Maximum Tc temperature	75°C
Lifetime rating	50,000 hrs
Moisture and dust rating	IP20

Protection functions

Relay with zero-crossing	Relay pulls in when the AC voltage is zero.
--------------------------	---

Accessories (optional)



Art. 161218 XZ-FLASH-A



Art. 166596 XZ-FLASH-B

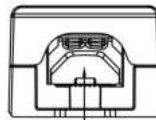

Wire diameter
 $\phi 3.5$ -- $\phi 9.5$ mm

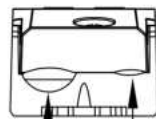

Wire diameter
 $\phi 6$ -- $\phi 11.5$ mm

Wire diameter
 $\phi 2$ -- $\phi 6$ mm

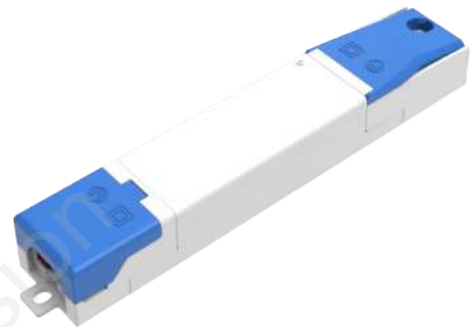

Dimensions	Length (mm)	Width (mm)	Height (mm)
XZ-FLASH-A	40.2	29	21
XZ-FLASH-B	53.6	29	21
Driver incl. XZ-FLASH-B + XZ-FLASH-A	165.6	29	21

Dimensions

Housing dimensions

Length (L)	105 mm
Width (W)	29 mm
Height (H)	21 mm
Weight	0.046 kg

Packaging details

Packing Units	60 pcs.
Carton Size	313 × 177 × 147 mm
Weight	2.4 Kg

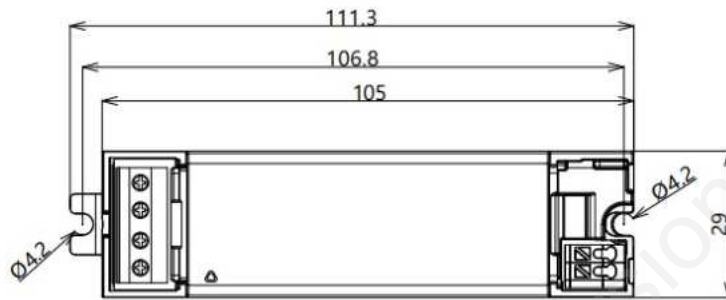

Ratio 1,000

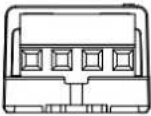

unit: mm
tol: ± 0.2 mm

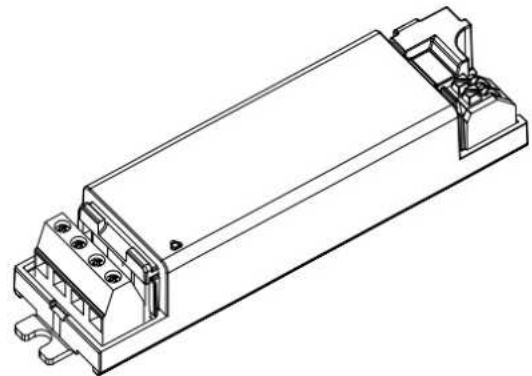

Applicable wiring diagram

